

DRAWING TYPE CUSTOMER DRAWING

MARK	DATE	DESCRIPTION	DESIGN
A	2023.08.28	NEW	HJY

组装线缆后的连接器尺寸

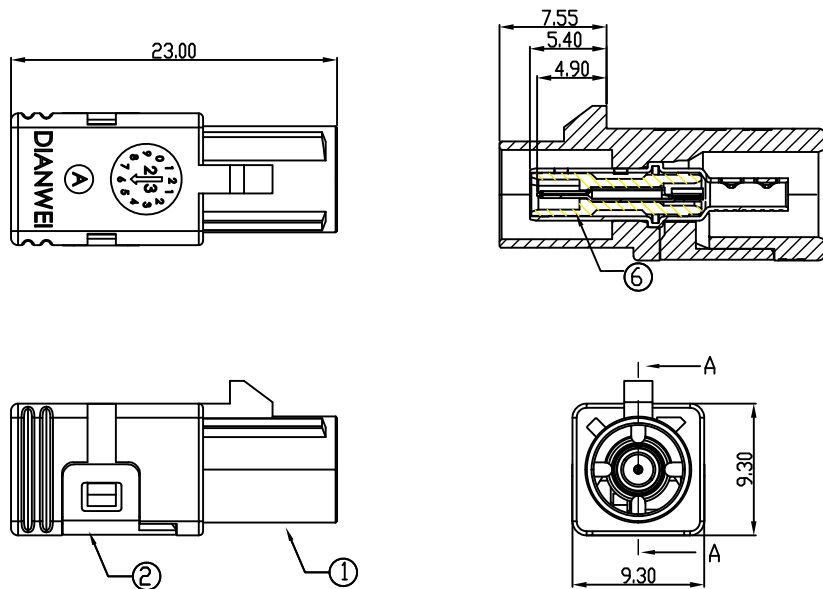

厂内完成的组件

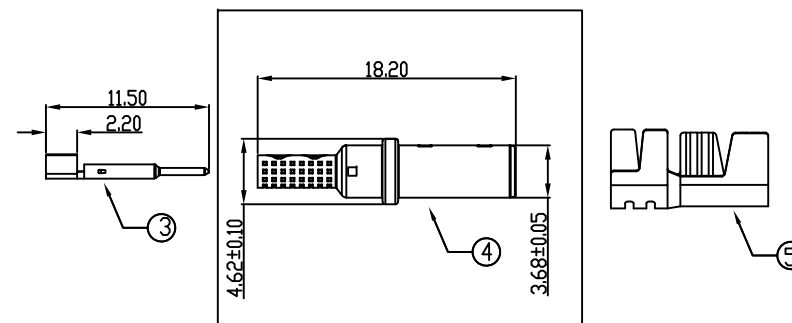

NOTES:

1. Contact resistance: 50mOHM Max,
2. VSWR:0-6GHz 1.58Max
3. Rating Voltage: 60V/DC.
4. Rating current: 1A/PIN.
4. Insulation resistance: 1000MOHM Min.
5. Mating cycles: 25 TIMES Min.
6. Operation Temperature:-40°C~+105°C
7. Part 3.4.5 is assembled together and the other parts are individually packaged

序号	名称	料号	材质	数量	表面处理
⑥	绝缘体	7.03M9.001010	LCP	1	无
⑤	线夹	7.03S5.001712	铜合金	1	Ni
④	外导体	7.03S9.000730	铜合金	1	Ni
③	端子	7.03T9.001210	铜合金	1	Au
②	二次锁扣	7.03M5.001A3X	PA66	1	无
①	塑胶外壳	7.03M9.00103X	PA66	1	无

装配 BOM 表

UNLESS OTHERWISE SPECIFIED TOLERANCE			
ANG	TOL	DIM	TOL
.X	±2.0°	.X	±0.50
.XX	±1.0°	.XX	±0.30
.XXX	±0.5°	.XXX	±0.20

DIANWEI

东莞市钿威电子科技有限公司
DONGGUAN DIANWEI ELECTRONIC TECHNOLOGY CO., LTD

Tel: +86-769-8788 8322 Fax: +86-769-8788 8321 E-mail: sales@ dianwei.cn Http://www.dianwei.cn

DRAWING NO	PART NAME:	FAKRA线公连接器 (冲压版本)			
	PART NO.	7.03A9.00101X			
APPROVED	VERIFIED	DESIGN	DATE	UNITS	SCALE
			2023.08.28	mm	1:1
				PAGE	REV
				1/2	A

DRAWING TYPE

CUSTOMER DRAWING

MARK

DATE

DESCRIPTION

DESIGN

A

2023.08.28

新版发行

HJY

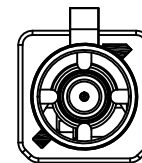
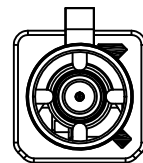
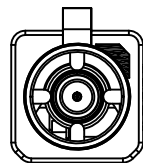
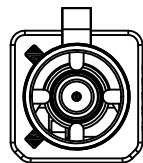
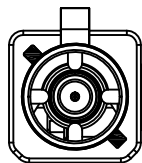
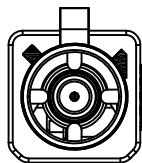
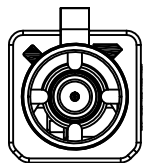

7.03A9.001010
A TYPE
(Black 黑色9005)

7.03A9.001011
B TYPE
(White 白色9001)

7.03A9.001012
C TYPE
(Blue 蓝色5005)

7.03A9.001013
D TYPE
Bordeaux 枣红色/4004

7.03A9.001014
E TYPE
Green 绿色/6002

7.03A9.001015
F TYPE
Brown 棕色/8011

7.03A9.001016
G TYPE
Grey 灰色/7031

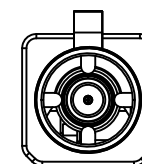
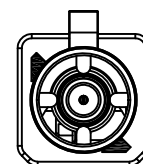
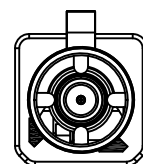
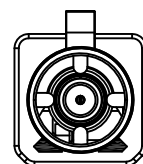
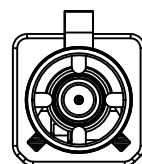
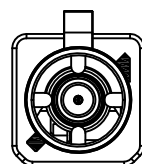
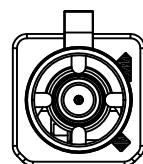

7.03A9.001017
H TYPE
Violet 紫罗兰/4003

7.03A9.001018
I TYPE
Beige 米黄色/1001

7.03A9.001019
K TYPE
Curry 咖喱色/1027

7.03A9.00101A
L TYPE
Camine Red 深红
/3002

7.03A9.00101B
M TYPE
Pastel Orange
粉橙色/2003

7.03A9.00101C
N TYPE
Pastel Green
粉绿色/6019

7.03A9.00101D
Z TYPE
Water Blue
水蓝色/5021

DIANWEI

东莞市钿威电子科技有限公司

DONGGUAN DIANWEI ELECTRONIC TECHNOLOGY CO., LTD

Tel: +86-769-8788 8322

Fax: +86-769-8788 8321

E-mail: sales@ dianwei.cn

Http://www.dianwei.cn

UNLESS OTHERWISE
SPECIFIED TOLERANCE

ANG	TOL	DIM	TOL
.X	±2.0°	.X	±0.30
.XX	±1.0°	.XX	±0.20
.XXX	±0.5°	.XXX	±0.10

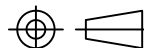

DRAWING NO

PART NAME:

FAKRA线公连接器 (冲压版本)

PART NO.

7.03A9.00101X

DATE

UNITS

SCALE

PAGE

REV

2023.08.28

mm

1:1

2/2

A

QP-04-33-B