

图面类型 内部发行文件

MARK	DATE	DESCRIPTION	DESIGN
A	2021.03.26	NEW	HJY

组装线缆后的连接器尺寸

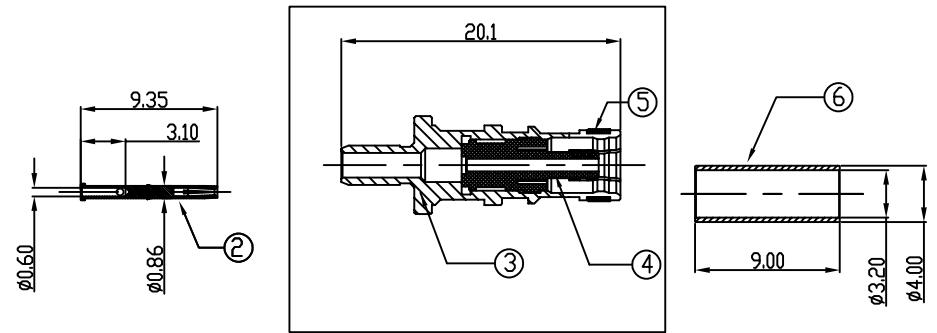
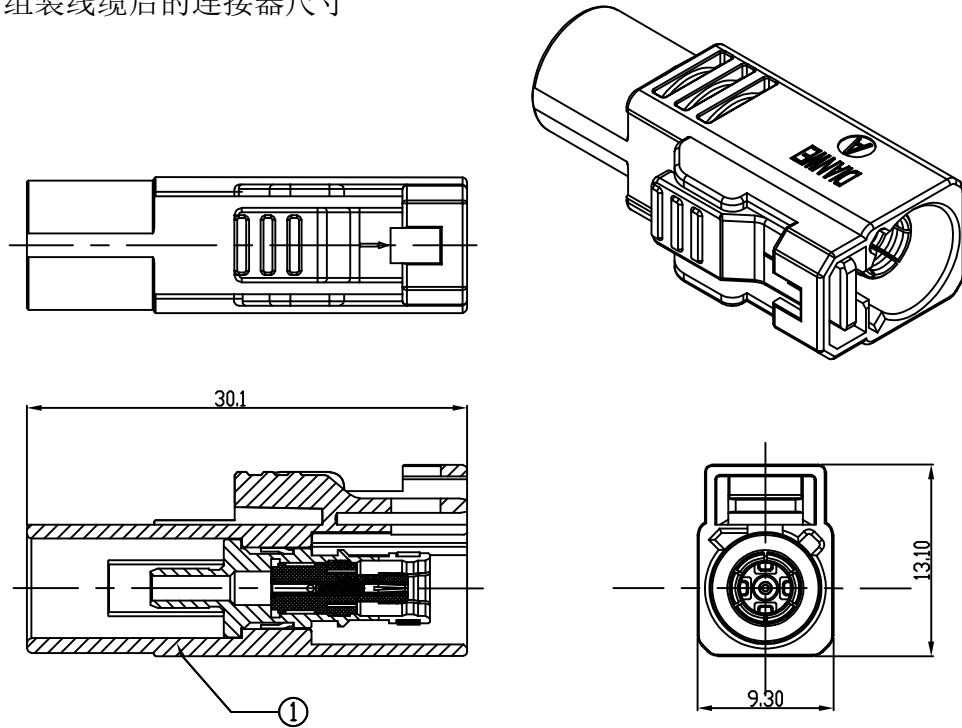

NOTES:

- Contact resistance: 50mOHM Max,
- VSWR:0-6GHz 1.58Max
- Rating Voltage: 60V/DC.
- Rating current: 1A/PIN.
- Insulation resistance: 1000MOHM Min.
- Mating cycles: 25 TIMES Min.
- Operation Temperature::-40℃~+105℃
- Part 3.4.5 is assembled together and the other parts are individually packaged

装配BOM表

⑥	线夹	7.03J3.000780	COPPER ALLOY	1	Ni
⑤	卡圈	7.03S4.001040	COPPER ALLOY	1	Ni
④	绝缘体	7.03M4.001010	LCP	1	无
③	主体	7.03J4.000770	COPPER ALLOY	1	Ni
②	插孔	7.03J4.000290	COPPER ALLOY	1	Au
①	壳体	7.03M4.00113X	PA66	1	无
序号	名称	零件料号	材质	数量	表面处理

UNLESS OTHERWISE SPECIFIED TOLERANCE			
ANG	TOL	DIM	TOL
.X	±2.0°	.X	±0.50
.XX	±1.0°	.XX	±0.30
.XXX	±0.5°	.XXX	±0.20

DIANWEI 东莞市钿威电子科技有限公司

DONGGUAN DIANWEI ELECTRONIC TECHNOLOGY CO., LTD

Tel: +86-769-8788 8322 Fax: +86-769-8788 8321 E-mail: dianwei@188.com Http://www.dianwei.cn

	DRAWING NO	PART NAME:	非防水FAKRA连接器 (F)			
	APPROVED	VERIFIED	DESIGN	PART NO.	7.03A4.00101X	
HJY		CXJ	DATE	UNITS	SCALE	PAGE
			2021.03.26	mm	1:1	1/2
						REV
						A

1 2 3 4 5 6 7 8 9 10 11 12
 图面类型 内部发行文件

MARK	DATE	DESCRIPTION	DESIGN
A	2021.03.26	新版发行	HJY

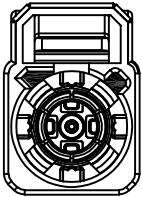
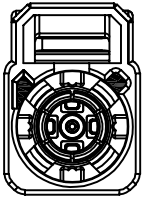
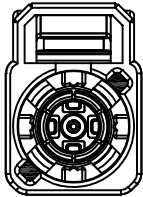
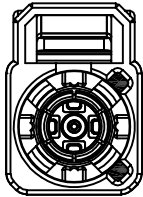
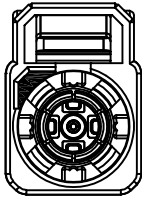
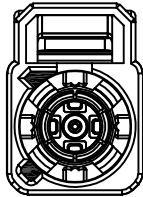
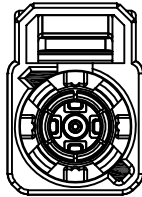
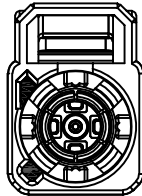
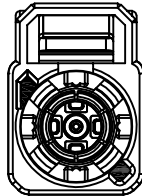
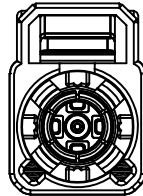
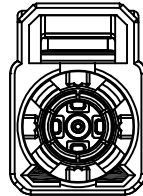
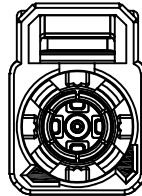
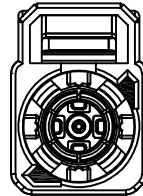
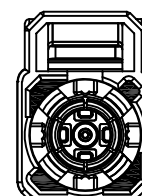
						
7.03A4.001010 A TYPE (Black 黑色9005)	7.03A4.001011 B TYPE (White 白色9001)	7.03A4.001012 C TYPE (Blue 蓝色5005)	7.03A4.001013 D TYPE Bordeaux 枣红色/4004	7.03A4.001014 E TYPE Green 绿色/6002	7.03A4.001015 F TYPE Brown 棕色/8011	7.03A4.001016 G TYPE Grey 灰色/7031
						
7.03A4.001017 H TYPE Violet 紫罗兰/4003	7.03A4.001018 I TYPE Beige 米黄色/1001	7.03A4.001019 K TYPE Curry 咖喱色/1027	7.03A4.00101A L TYPE Camine Red 深红 /3002	7.03A4.00101B M TYPE Pastel Orange 粉橙色/2003	7.03A4.00101C N TYPE Pastel Green 粉绿色/6019	7.03A4.00101D Z TYPE Water Blue 水蓝色/5021

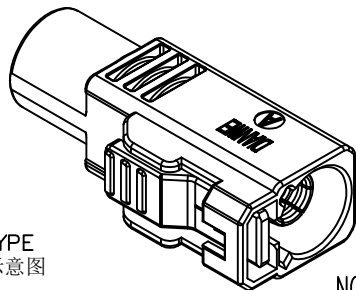

A TYPE
立体示意图

NOTE: ALL RIGHTS RESERVED, BANNED COPY!

UNLESS OTHERWISE SPECIFIED TOLERANCE			
ANG	TOL	DIM	TOL
.X	±2.0°	.X	±0.30
.XX	±1.0°	.XX	±0.20
.XXX	±0.5°	.XXX	±0.10

DIANWEI

东莞市钿威电子科技有限公司

DONGGUAN DIANWEI ELECTRONIC TECHNOLOGY CO., LTD

Tel: +86-769-8788 8322

Fax: +86-769-8788 8321

E-mail: dianwei@188.com

Http://www.dianwei.cn

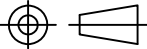
 APPROVED HJY	VERIFIED 	DRAWING NO	PART NAME:	非防水FAKRA连接器 (F)			
		DESIGN CXJ	PART NO.	7.03A4.00101X			
		DATE	UNITS	SCALE	PAGE	REV	
		2021.03.26	mm	1:1	2/2	A	