

DRAWING TYPE CUSTOMER DRAWING

MARK	DATE	DESCRIPTION	DESIGN
A	2021.12.17	NEW	CHEN

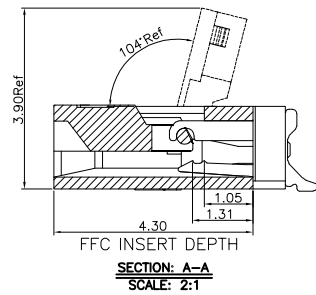

1. PART NO. LEGEND:
 8.25A0.***200
 1 2 3 4 5
1. SERIES NAME: 8.25A0=1.0MM FFC/FPC SWING COVER CONNECTOR (H=1.8mm)
 2. CONTACT PIN NUMBER: ***=CONTACT PIN NUMBER
 3. CONTACT AREA PLATING SPEC: PART GOLD PLATING; 2=1~3u", 3=5u", 4=10u", 5=15u"
 SOLDER AREA PLATING SPEC: PART GOLD PLATING; 2=1~3u", 3=5u", 4=10u", 5=15u"
 4. UNSPECIFIED: 0=ONSENSE
 5. UNSPECIFIED: 0=ONSENSE
2. PERFORMANCE:
 2.1: CURRENT RATING: 0.5A/PIN.
 2.2: VOLTAGE RATING: 50V (AC/DC).
 2.3: CONTACT RESISTANCE: INITIAL VALUE 30mOHM Max,
 2.4: INSULATION RESISTANCE: 500MOHM Min.
 2.5: DIELECTRIC WITHSTANDING VOLTAGE: 250V AC FOR 1MINUTE;
 2.6: DURABILITY: 20 TIMES Min.
 2.7: OPERATING TEMPERATURE: -40°C~+85°C
 OPERATING HUMIDITY RANGE: 20% TO 85%

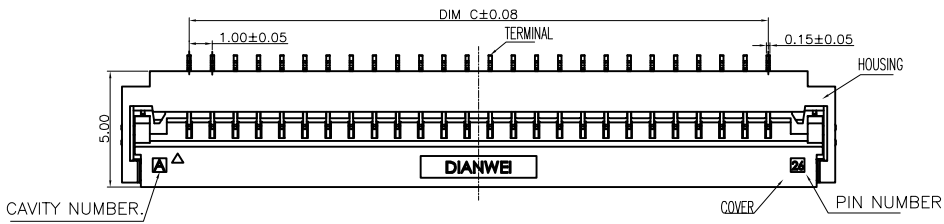
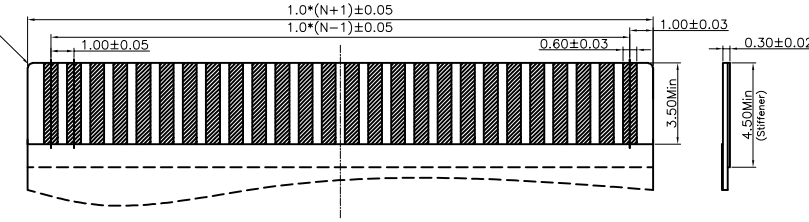
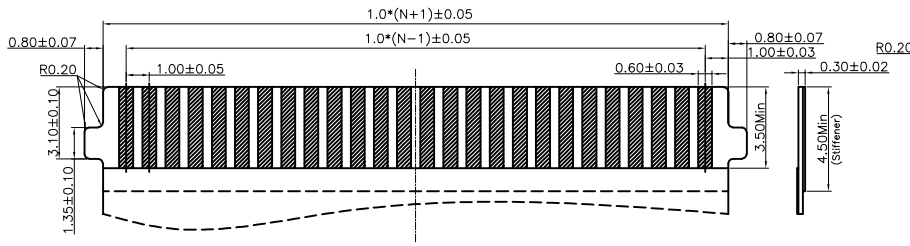
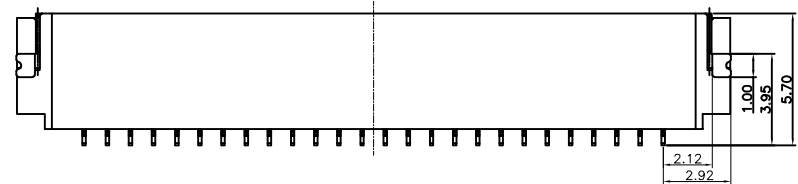
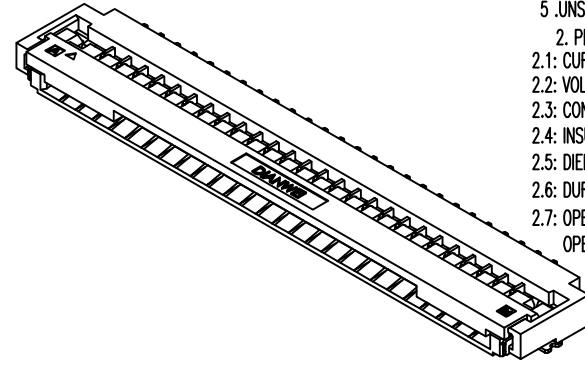
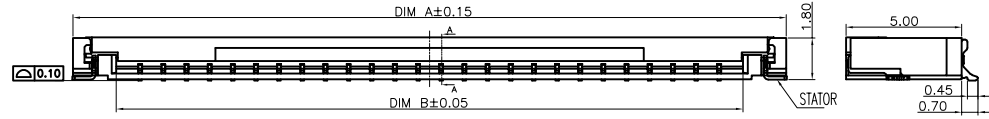

RECOMMENDED FFC/FPC

RECOMMENDED FFC/FPC

Pin No.	P/N	DIM A	DIM B	DIM C
04	8.25A0.004200	8.80	5.06	3.00
05	8.25A0.005200	9.80	6.06	4.00
06	8.25A0.006200	10.80	7.06	5.00
08	8.25A0.008200	12.80	9.06	7.00
10	8.25A0.010200	14.80	11.06	9.00
12	8.25A0.012200	16.80	13.06	11.00
13	8.25A0.013200	17.80	14.06	12.00
14	8.25A0.014200	18.80	15.06	13.00
15	8.25A0.015200	19.80	16.06	14.00
16	8.25A0.016200	20.80	17.06	15.00
18	8.25A0.018200	22.80	19.06	17.00
20	8.25A0.020200	24.80	21.06	19.00
24	8.25A0.024200	28.80	25.06	23.00
26	8.25A0.026200	30.80	27.06	25.00
28	8.25A0.028200	32.80	29.06	27.00
30	8.25A0.030200	34.80	31.06	29.00
36	8.25A0.036200	40.80	37.06	35.00
40	8.25A0.040200	44.80	41.06	39.00

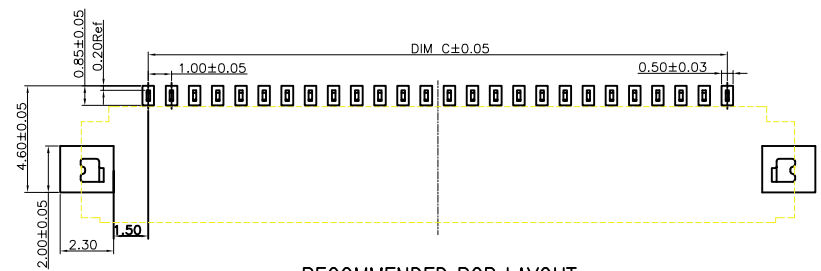

RECOMMENDED PCB LAYOUT

4	STATOR	COOPER ALLOY		2
3	TERMINAL	COOPER ALLOY		POSITIONS
2	COVER	THERMOPLASTIC UL94V-0	BLACK	1
1	HOUSING	THERMOPLASTIC UL94V-0	NATURAL	1
NO.	COMPONENTS	MATERIALS	FINISH/COLOR SPECIFICATION	QUANTITY

DIANWEI 东莞市钿威电子科技有限公司
 DONGGUAN DIANWEI ELECTRONIC TECHNOLOGY CO., LTD
 Tel: +86-769-8788 8322 Fax: +86-769-8788 8321 E-mail: sales@dianwei.cn Http://www.dianwei.cn

UNLESS OTHERWISE SPECIFIED TOLERANCE			
ANG	TOL	DIM	TOL
.X	±3.0°	.X	±0.20
.XX	±2.0°	.XX	±0.10
.XXX	±1.0°	.XXX	±0.05

APPROVED	VERIFIED	DRAWING NO	PART NAME:	1.0MM FFC/FPC SWING COVER CONNECTOR(H=1.8mm)			
		8.25A0-C	PART NO.	8.25A0.***200			
CHEN		DESIGN	DATE	UNITS	SCALE	PAGE	REV
			2021.12.17	mm	1:1	1/1	A

NOTE: ALL RIGHTS RESERVED, BANNED COPY!

DRAWING TYPE

PACKAGE DRAWING

MARK

DATE

DESCRIPTION

DESIGN

A

2021.12.21

PROPOSAL

CHEN

PULL OUT DIRECTION

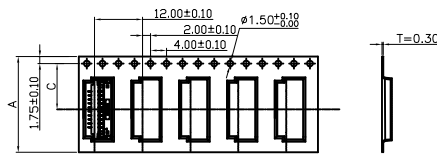

4~10PIN REEL

NOTES:

- MATERIAL:
 - CARRY TAPE:HIPS,T=0.30±0.05mm,CLEAR
 - REEL:HIPS,
 - SHIM:PE,CLEAR.
- PRIMARY PACKING:2000PCS/REEL.
- SECONDARY PACKING:SEE PACKING LIST
- PEELING RESISTANCE: 0.2~1.5N(20~150gf); PEELING ANGLE: 165°~180°; PEELING SPEED: 300mm/minutes.

5. QTY. LIST:

NO. OF POS.	A	B	C	PCS/REEL
4~10 PIN	24.0	28.4	11.5	2000
11~16 PIN	32.0	28.4	14.2	2000
17~26 PIN	44.0	40.4	20.2	2000
27~37 PIN	56.0	52.4	26.2	2000
38~51 PIN	72.0	68.4	34.2	2000

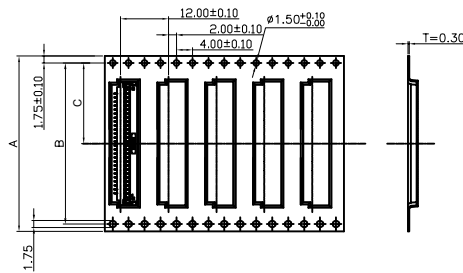

11~51PIN REEL

每盘使用PE带真空包装

TOTAL N LAYERS

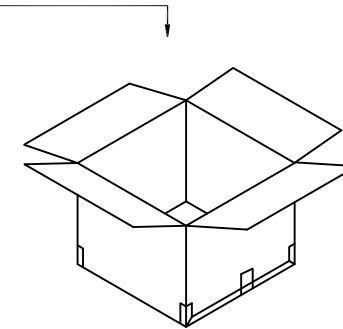
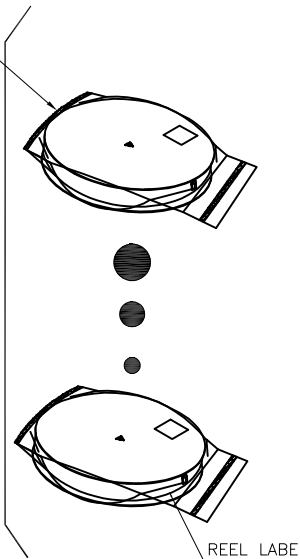

TRANSPARENT GULE TAPE

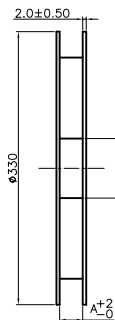
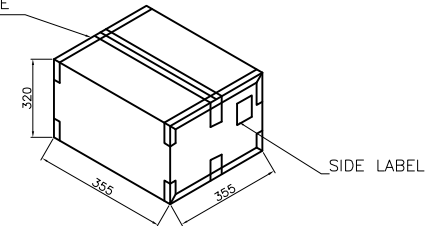

PULL OUT DIRECTION

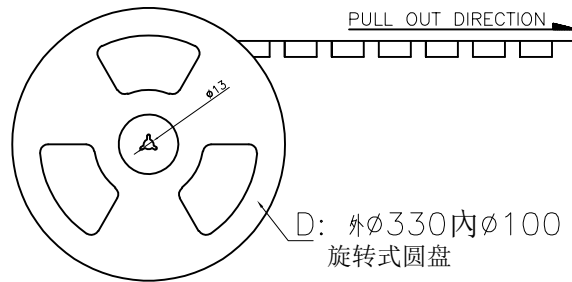

PULL OUT DIRECTION

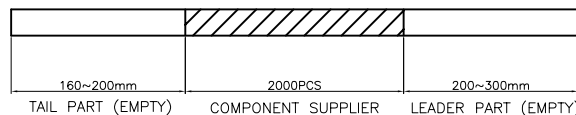

TAIL PART (EMPTY) COMPONENT SUPPLIER LEADER PART (EMPTY)

DIANWEI

东莞市钿威电子科技有限公司

DONGGUAN DIANWEI ELECTRONIC TECHNOLOGY CO., LTD

Tel: +86-769-8788 8322 Fax: +86-769-8788 8321 E-mail: sales@ dianwei.cn Http://www.dianwei.cn

UNLESS OTHERWISE SPECIFIED TOLERANCE

ANG	TOL	DIM	TOL
.X	±3.0°	.X	±0.20
.XX	±2.0°	.XX	±0.10
.XXX	±1.0°	.XXX	±0.05

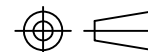

APPROVED

VERIFIED

DRAWING NO

8.25A0-P

PART NAME:

1.0MM FFC/FPC SWING COVER CONNECTOR (H=1.8mm) PACKAGE SPEC

PART NO.

8.25A0.***200

DESIGN

CHEN

DATE

2021.12.21

UNITS

mm

SCALE

1:1

PAGE

1/1

REV

A

NOTE: ALL RIGHTS RESERVED,BANNED COPY!

QP-04-33-B